

Ultra Low Noise, High IP3

Monolithic Amplifier

PMA2-252LN+

50Ω 1.5 to 2.5 GHz



2mm x 2mm

The Big Deal

- Ultra Low Noise Figure, 0.8 dB
- High Gain, High IP3, +30 dBm
- Adjustable Current, 25 to 80 mA
- May be used as a replacement for MGA-632P8^{a,b}

Product Overview

Mini-Circuits PMA2-252LN+ is a E-PHEMT based Ultra-Low Noise MMIC Amplifier with a unique combination of low noise and high IP3 making this amplifier ideal for sensitive high dynamic range receiver applications. This design operates on a single 3 to 4V supply.

Key Features

| Feature | Advantages |
|------------------------------------|--|
| Ultra Low Noise, 0.8 dB at 1.8 GHz | Excellent noise figure performance. Increases signal to noise ratio. |
| High IP3, +30 dBm at 1.8 GHz | Combining Low Noise and High IP3 makes this MMIC amplifier ideal for use in Low Noise Receiver Front End (RFE) as it gives the user advantages at both ends of the dynamic range: sensitivity & two-tone IM performance. |
| Adjustable Current | Provides users ability to set current consumption over a wide range from 25 to 80 mA. |
| 2mm x 2mm 8 lead MCLP Package | Low Inductance, repeatable transitions, excellent thermal contact to PCB |
| Max Input Power, +27 dBm | Ruggedized design operates up to high input powers often seen at Receiver inputs eliminating the need for an external limiter. |
| High Reliability | Low, small signal operating current of 57 mA nominal maintains junction temperatures typically below 100°C at 85°C ground lead temperature. |

Notes:

- Suitability for model replacement within a particular system must be determined by and is solely the responsibility of the customer based on, among other things, electrical performance criteria, stimulus conditions, application, compatibility with other components and environmental conditions and stresses.
- The Avago MGA-632P8 part number is used for identification and comparison purposes only.

Notes

- Performance and quality attributes and conditions not expressly stated in this specification document are intended to be excluded and do not form a part of this specification document.
- Electrical specifications and performance data contained in this specification document are based on Mini-Circuit's applicable established test performance criteria and measurement instructions.
- The parts covered by this specification document are subject to Mini-Circuits standard limited warranty and terms and conditions (collectively, "Standard Terms"); Purchasers of this part are entitled to the rights and benefits contained therein. For a full statement of the Standard Terms and the exclusive rights and remedies thereunder, please visit Mini-Circuits' website at www.minicircuits.com/MCLStore/terms.jsp



Ultra Low Noise, High IP3

Monolithic Amplifier

1.5-2.5 GHz

Product Features

- Low Noise figure, 0.8 dB at 1.8 GHz
- High IP3, 30 dBm typ. at 1.8 GHz
- P1dB 17.9 dBm typ. at 1.8 GHz
- Adjustable Current, 25 to 80 mA
- Adjustable Gain, ± 1.5 dB
- Active Bias



PMA2-252LN+

CASE STYLE: MC1631

Typical Applications

- Base station infrastructure
- Satellite Communication (Inmarsat)
- LTE
- GPS
- Tactical Air Navigation

+RoHS Compliant

The +Suffix identifies RoHS Compliance. See our web site for RoHS Compliance methodologies and qualifications

General Description

The PMA2-252LN+ (RoHS compliant) amplifier is fabricated using E-PHEMT technology and offers extremely high dynamic range with ultra low noise figure and good input and output return loss. It has repeatable performance from lot to lot and is enclosed in a 2mm x 2mm x 0.55mm package for very good thermal performance.

simplified schematic and pad description

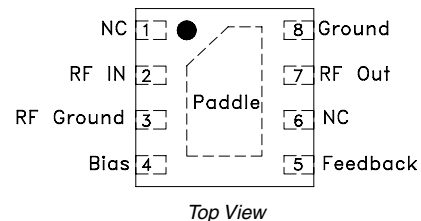
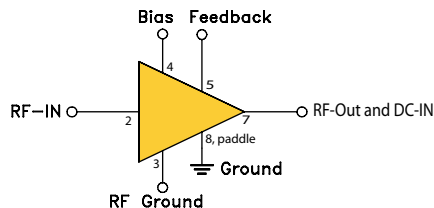

| Function | Pad Number | Description (Ref: Figure1) |
|---------------|------------|--|
| RF IN | 2 | Connects to RF input via C1 and Pad 3 via L1 |
| RF-OUT | 7 | Connects to RF out via C2, Pad 5 via R1 and C3 |
| RF-Ground | 3 | Connects to ground via C4 and Pad 2 via L1 |
| Bias | 4 | Connects to Supply voltage (Vs) via Rbias |
| Feedback | 5 | Connected to pads via R1 and C3 |
| No Connection | 1,6 | Not used internally. Pin 1 Connected to ground on test board |
| Ground | 8 & paddle | Connects to ground |

Notes

- A. Performance and quality attributes and conditions not expressly stated in this specification document are intended to be excluded and do not form a part of this specification document.
 B. Electrical specifications and performance data contained in this specification document are based on Mini-Circuit's applicable established test performance criteria and measurement instructions.
 C. The parts covered by this specification document are subject to Mini-Circuits standard limited warranty and terms and conditions (collectively, "Standard Terms"); Purchasers of this part are entitled to the rights and benefits contained therein. For a full statement of the Standard Terms and the exclusive rights and remedies thereunder, please visit Mini-Circuits' website at www.minicircuits.com/MCLStore/terms.jsp



Electrical Specifications⁽¹⁾ at 25°C, unless noted

| Parameter | Condition (GHz) | Vs=4V | | | Vs=3V | Units |
|--|-----------------|-------|-------|------|-------|-------|
| | | Min. | Typ. | Max. | Typ. | |
| Frequency Range | | 1.5 | | 2.5 | | GHz |
| Noise Figure | 1.5 | | 0.7 | | 0.7 | dB |
| | 1.8 | | 0.8 | | 0.8 | |
| | 2.0 | | 0.8 | | 0.9 | |
| | 2.2 | | 0.8 | | 1.1 | |
| | 2.5 | | 1.2 | | 1.1 | |
| Gain | 1.5 | — | 19.5 | — | 18.8 | dB |
| | 1.8 | — | 18.6 | — | 17.8 | |
| | 2.0 | 15.8 | 17.6 | 19.5 | 16.8 | |
| | 2.2 | — | 16.5 | — | 15.7 | |
| | 2.5 | — | 15.7 | — | 14.8 | |
| Input Return Loss | 1.5 | | 21.3 | | 17.5 | dB |
| | 1.8 | | 19.9 | | 15.4 | |
| | 2.0 | | 18.0 | | 14.4 | |
| | 2.2 | | 16.3 | | 13.4 | |
| | 2.5 | | 14.9 | | 13.0 | |
| Output Return Loss | 1.5 | | 10.0 | | 10.8 | dB |
| | 1.8 | | 23.3 | | 28.5 | |
| | 2.0 | | 18.2 | | 16.9 | |
| | 2.2 | | 12.9 | | 11.9 | |
| | 2.5 | | 8.3 | | 7.9 | |
| Output Power @ 1 dB compression ⁽²⁾ | 1.5 | | 18.5 | | 16.2 | dBm |
| | 1.8 | | 17.9 | | 15.9 | |
| | 2.0 | | 17.8 | | 15.6 | |
| | 2.2 | | 17.4 | | 15.3 | |
| | 2.5 | | 16.2 | | 13.9 | |
| Output IP3 | 1.5 | | 31.1 | | 27.1 | dBm |
| | 1.8 | | 30.1 | | 25.5 | |
| | 2.0 | | 30.0 | | 25.3 | |
| | 2.2 | | 29.3 | | 24.8 | |
| | 2.5 | | 27.6 | | 23.2 | |
| Device Operating Voltage | | 3.8 | 4.0 | 4.2 | 3.0 | V |
| Device Operating Current at typical voltage ⁽²⁾ | | | 57 | 70 | 41 | mA |
| Device Current variation vs. Temperature at typical voltage ⁽³⁾ | | | -19.0 | | -3.4 | µA/°C |
| Device Current Variation vs Voltage | | | 0.018 | | 0.017 | mA/mV |
| Thermal Resitance | | | 53 | | 53 | °C/W |

⁽¹⁾ Measured on Mini-Circuits Characterization test board TB-642+. See Characterization Test Circuit (Fig. 1) R1=825Ω, R_{BIAS}=619Ω

⁽²⁾ Current increases at P1dB

⁽³⁾ (Current at 85°C - Current at -45°C)/130

Absolute Maximum Ratings

| Parameter | Ratings |
|-------------------------------------|---|
| Operating Temperature (ground lead) | -40°C to 85°C |
| Storage Temperature | -65°C to 150°C |
| Junction Temperature | 150°C |
| Total Power Dissipation | 0.55W |
| Input Power (CW), Vs=3V or 4V | +25 dBm (5 minutes max), +20 dBm (continuous) |
| DC Voltage (Vs) | 5.5 V |

Note:
 Permanent damage may occur if any of these limits are exceeded.
 Electrical maximum ratings are not intended for continuous normal operation.

DC Current Histogram at Vs=4V

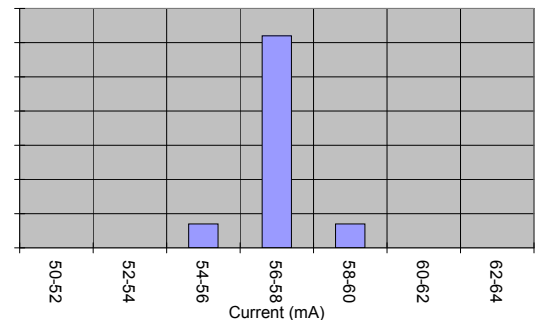

Notes
 A. Performance and quality attributes and conditions not expressly stated in this specification document are intended to be excluded and do not form a part of this specification document.
 B. Electrical specifications and performance data contained in this specification document are based on Mini-Circuit's applicable established test performance criteria and measurement instructions.
 C. The parts covered by this specification document are subject to Mini-Circuits standard limited warranty and terms and conditions (collectively, "Standard Terms"); Purchasers of this part are entitled to the rights and benefits contained therein. For a full statement of the Standard Terms and the exclusive rights and remedies thereunder, please visit Mini-Circuits' website at www.minicircuits.com/MCLStore/terms.jsp



Recommended Application and Characterization Test Circuit

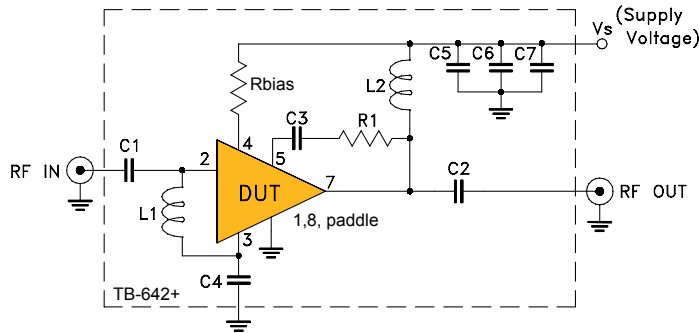

Fig 1. Application and Characterization circuit

Note: This block diagram is used for characterization. (DUT soldered on Mini-Circuits Characterization test board TB-642+)

Gain, Return loss, Output power at 1dB compression (P1 dB) , output IP3 (OIP3) and noise figure measured using Agilent’s N5242A PNA-X microwave network analyzer.

Conditions:

1. Gain and Return loss: Pin= -25dBm
2. Output IP3 (OIP3): Two tones, spaced 2.5 MHz apart, 2 dBm/tone at output.

Product Marking



Marking may contain other features or characters for internal lot control

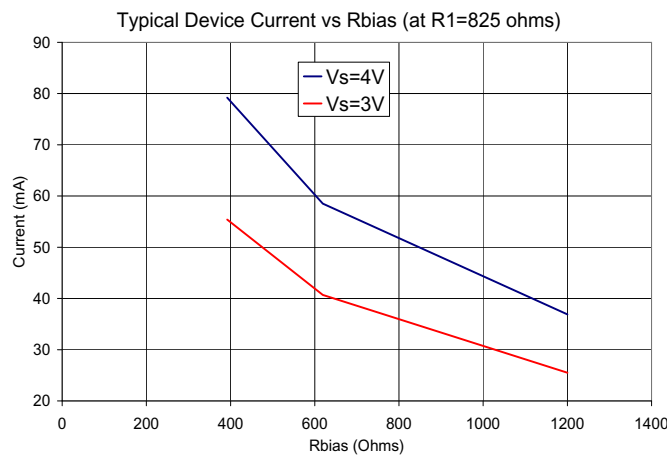

Notes

- A. Performance and quality attributes and conditions not expressly stated in this specification document are intended to be excluded and do not form a part of this specification document.
- B. Electrical specifications and performance data contained in this specification document are based on Mini-Circuit’s applicable established test performance criteria and measurement instructions.
- C. The parts covered by this specification document are subject to Mini-Circuits standard limited warranty and terms and conditions (collectively, “Standard Terms”); Purchasers of this part are entitled to the rights and benefits contained therein. For a full statement of the Standard Terms and the exclusive rights and remedies thereunder, please visit Mini-Circuits’ website at www.minicircuits.com/MCLStore/terms.jsp



Adjustable Gain Performance (vs. R1) at Vs=4V

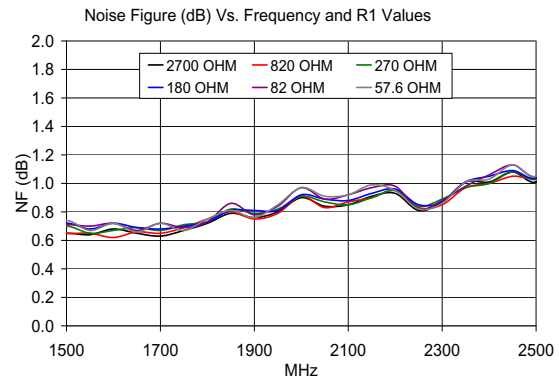
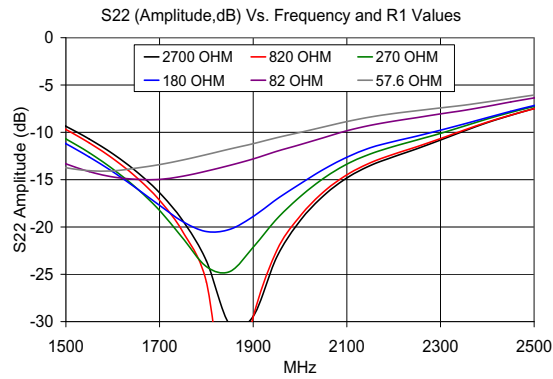
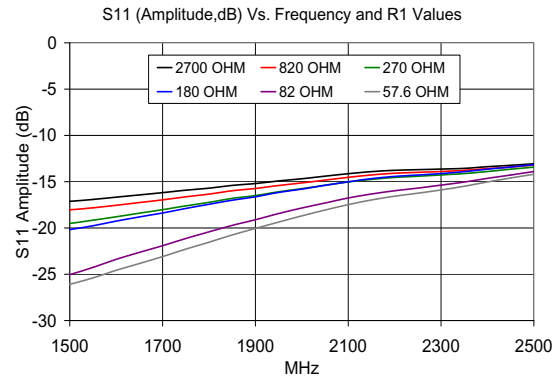
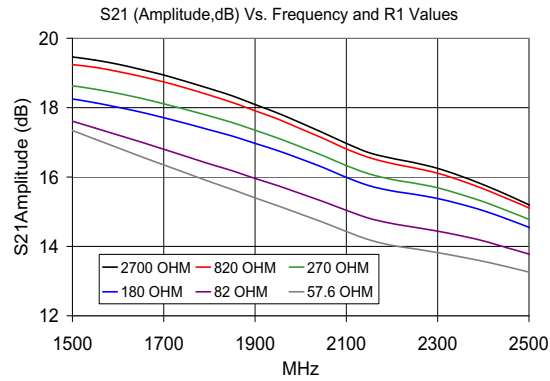

Adjustable Gain Performance (vs. R1) at Vs=3V

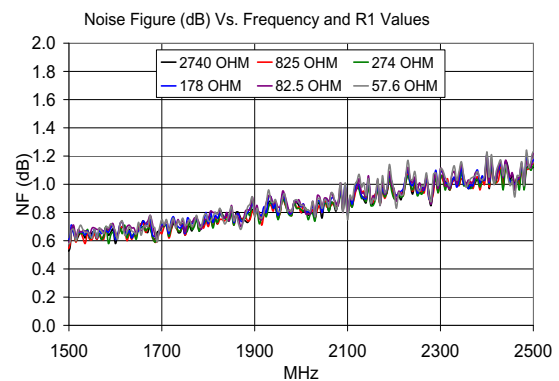
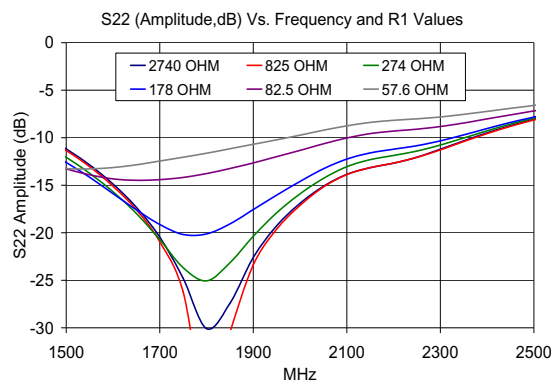
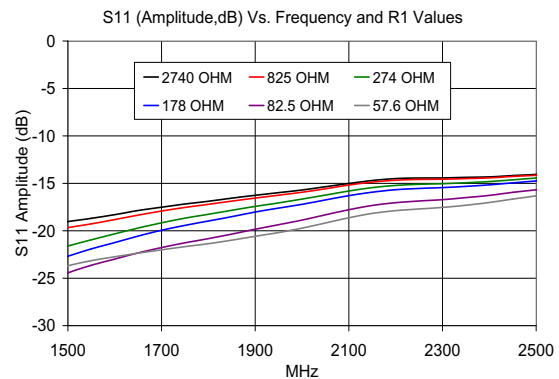
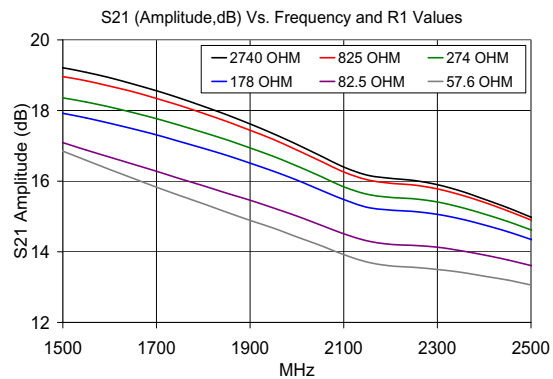

Notes

- A. Performance and quality attributes and conditions not expressly stated in this specification document are intended to be excluded and do not form a part of this specification document.
- B. Electrical specifications and performance data contained in this specification document are based on Mini-Circuit's applicable established test performance criteria and measurement instructions.
- C. The parts covered by this specification document are subject to Mini-Circuits standard limited warranty and terms and conditions (collectively, "Standard Terms"); Purchasers of this part are entitled to the rights and benefits contained therein. For a full statement of the Standard Terms and the exclusive rights and remedies thereunder, please visit Mini-Circuits' website at www.minicircuits.com/MCLStore/terms.jsp



| Additional Detailed Technical Information | |
|---|---|
| <i>additional information is available on our dash board. To access this information click here</i> | |
| Performance Data | Data Table |
| | Swept Graphs |
| | S-Parameter (S2P Files) Data Set (.zip file) |
| Case Style | MC1631 <i>Plastic package, exposed paddle, lead finish: matte tin</i> |
| Tape & Reel Standard quantities available on reel | F108 <i>7" reels with 20, 50, 100, 200, 500, 1K or 2K devices</i> |
| Suggested Layout for PCB Design | PL-360 |
| Evaluation Board | TB-642+ |
| Environmental Ratings | ENV08T1 |

ESD Rating

Human Body Model (HBM): Class 1A (250 to <500V) in accordance with ANSI/ESD STM 5.1 - 2001

Machine Model (MM): Class M1 (pass 25V) in accordance with ANSI/ESD STM5.2-1999

MSL Rating

Moisture Sensitivity: MSL1 in accordance with IPC/JEDEC J-STD-020D

MSL Test Flow Chart

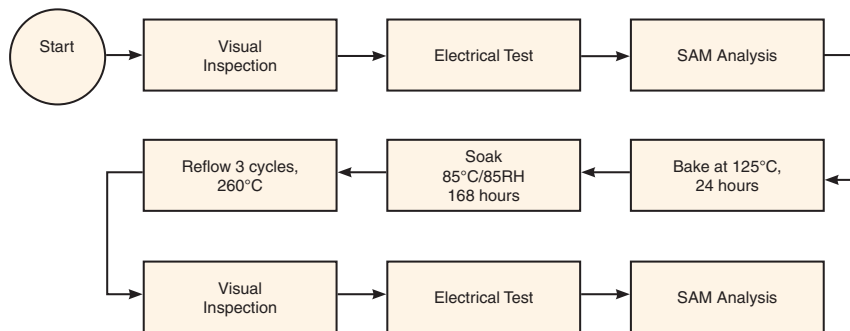

Notes

- A. Performance and quality attributes and conditions not expressly stated in this specification document are intended to be excluded and do not form a part of this specification document.
- B. Electrical specifications and performance data contained in this specification document are based on Mini-Circuit's applicable established test performance criteria and measurement instructions.
- C. The parts covered by this specification document are subject to Mini-Circuits standard limited warranty and terms and conditions (collectively, "Standard Terms"); Purchasers of this part are entitled to the rights and benefits contained therein. For a full statement of the Standard Terms and the exclusive rights and remedies thereunder, please visit Mini-Circuits' website at www.minicircuits.com/MCLStore/terms.jsp

